



Assessment of basil varieties for production in the UVI Aquaponic System



Donald Bailey¹, Rhuano S. Ferrarezi², Seti Balkaran³ and Jomanni Bernier³

¹Research Specialist, Horticulture and Aquaculture program, Agriculture Experiment Station (AES), University of the Virgin Islands (UVI), Kingshill, VI 00850. E-mail: [dbailey@uvi.edu](mailto:d Bailey@uvi.edu)

²Research Assistant Professor, Horticulture and Aquaculture program, AES, UVI, Kingshill, VI 00850. E-mail: rhuano.ferrarezi@uvi.edu

³Undergraduate students, UVI, Kingshill, VI 00850. E-mail: seti008@yahoo.com and jomanni_b@yahoo.com



Introduction

Basil is a fast-growing crop in aquaponics systems. Previous research has indicated that basil is a high cash-value, and the evaluation of specie adaptation in tropical conditions is mandatory to recommend new varieties for the UVI Commercial Aquaponic System.

Objectives

Two trials were conducted to assess different basil varieties for production in the UVI Commercial Aquaponic System.

Material & Methods

UVI Commercial Aquaponic System. The system used for this study is represented on Fig. 1. Components are listed on Table 1.

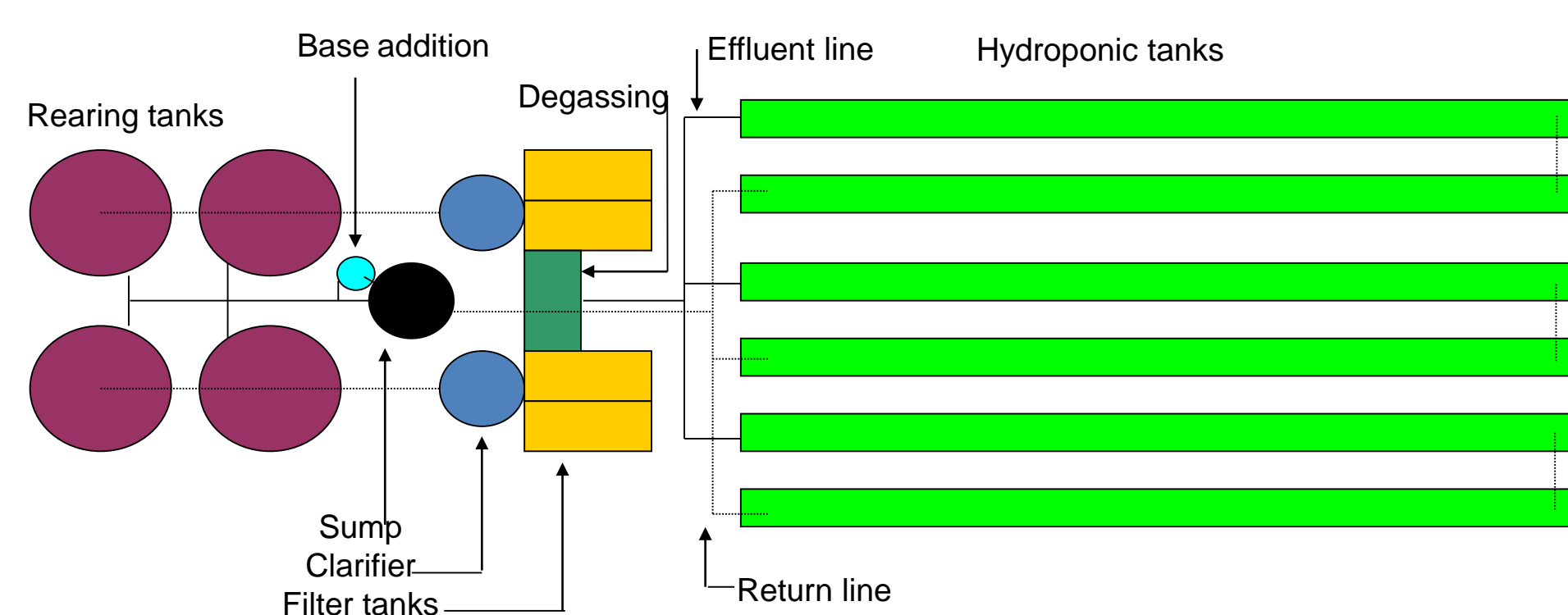

Fig. 1. Schematic drawing of the UVI Commercial Aquaponic System.

Table 1. Components of the UVI Commercial Aquaponic System.

Component	Volume (m ³)
4 fish rearing tanks	7.8
2 cylindro-conical clarifiers	3.8
4 filter tanks	0.7
1 degassing tank	0.7
6 hydroponic tanks	11.3
1 sump	0.6
1 base addition tank	0.2
Total water volume	110
Total plant growing area	214 m ²
Land area	0.05 ha

Procedures. Basil seedlings were transplanted into floating rafts in the system. Planting density was 16 plants/m² with individual plants 15 x 20 cm apart. Twenty-two plants were transplanted into an area of 1.48 m².

Treatments and experimental design. For Trial 1 (Summer 2015), we tested five varieties in completely randomized blocks (CRB) with four replications. For Trial 2 (Fall 2015), we tested seven varieties in CRB with three replications. Varieties are listed in Table 2.

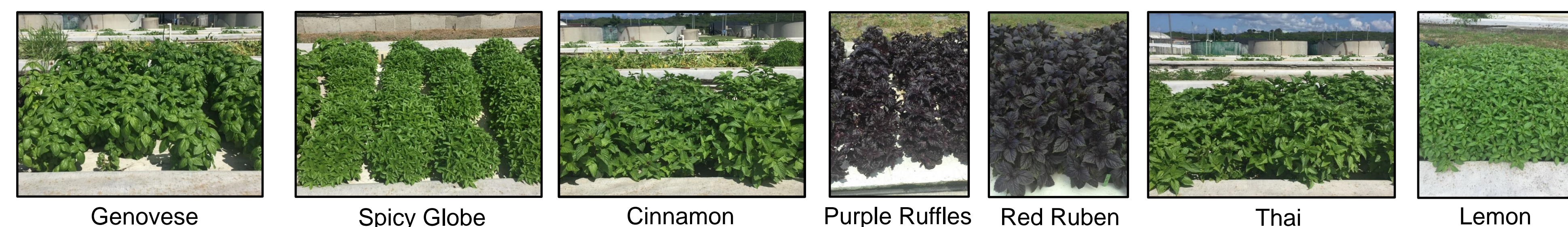

In the first trial (Summer 2015), 'Spicy Globe' (13.864 kg/m²) and 'Genovese' (14.774 kg/m²) presented the highest total yield and 'Purple Ruffles' the lowest (4.143 kg/m²) ($P < 0.0001$, Fig. 2A). Fresh weight followed the same trend ($p < 0.0001$, Fig. 3A), and dry weight was higher on 'Genovese' (0.882 kg/m²) ($P < 0.0001$, Fig. 3C). Leaf anthocyanin was higher on the red varieties 'Red Ruben' (28.35 ACI) and 'Purple Ruffles' (34.36 ACI) ($P < 0.0001$, Fig. 4A). Chlorophyll content was higher on 'Genovese' (48.59 CCI) ($P < 0.0001$, Fig. 4A).

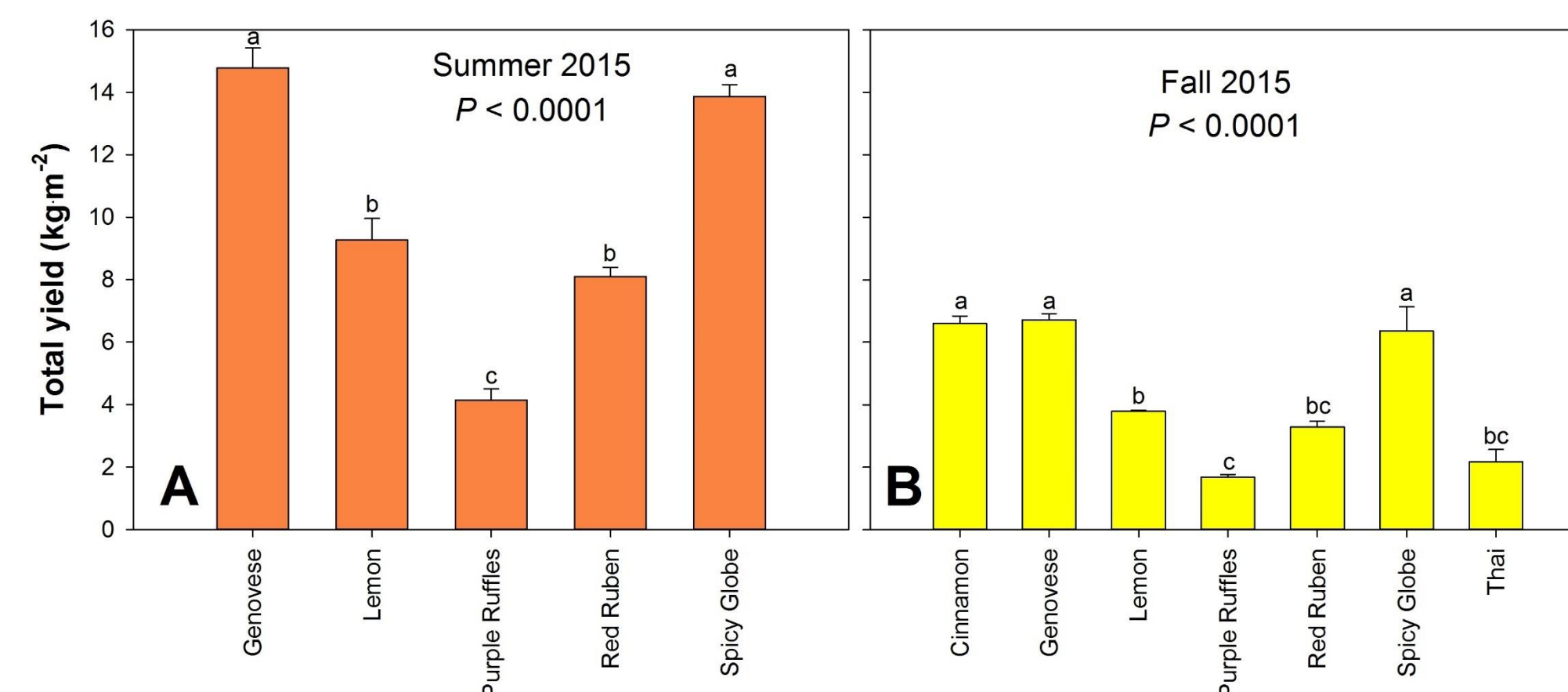

Fig. 2. Total yield on Summer 2015 (A) and Fall 2015 (B) for different varieties of basil.

In the second trial (Fall 2015), 'Genovese' (6.707 kg/m²), 'Cinnamon' (6.602 kg/m²) and 'Spicy Globe' (6.354 kg/m²) showed the highest total yield and 'Purple Ruffles' the lowest (1.679 kg/m²) ($P < 0.0001$, Fig. 2B). Fresh weight followed the same tendency ($P < 0.0001$, Fig. 3B), and dry weight was higher on 'Cinnamon' (0.325 kg/m²) ($P < 0.0001$, Fig. 3D). Leaf anthocyanin differed in all varieties over time, with larger values on

Table 2. Basil varieties used to recommend new varieties for the UVI Commercial Aquaponic System.

Trial 1 (Summer 2015)	Trial 2 (Fall 2015)
Genovese	Genovese
Spicy Globe	Spicy Globe
Lemon	Lemon
Purple Ruffles	Purple Ruffles
Red Ruben	Red Ruben
	Cinnamon
	Thai

Measurements. Plant height and width in two directions were measured before each harvest in four plants to calculate plant growth index $((\text{height} + \text{width}_1 + \text{width}_2) / 3)$. Two plants were sampled from each treatment at each harvest to determine fresh and dry weight. Chlorophyll and anthocyanin were measured in two plants before the final harvest in the first trial and before each harvest in the second trial. Chlorophyll was measured with a MC-100 meter (Apogee Instruments, Logan, UT), and anthocyanin using a ACM-200 plus meter (Opti-sciences, Hudson, NH).

Statistical analysis. GLM procedures of SAS v. 9.4 (SAS Foundation, Cary, NC), with basil varieties and days after transplanting (DAT) readings as the main effects in the model.

Results & Discussion

'Purple Ruffles' (80.5 ACI) and 'Red Ruben' (36.5 ACI) ($P < 0.0001$, Fig. 4B). Chlorophyll content was a response of variety and plant growth, ranging from 12.06 ('Lemon') to 17.99 CCI ('Cinnamon') ($P = 0.0002$, Fig. 5B). Values increased overtime ($P < 0.0001$, Fig. 5C).

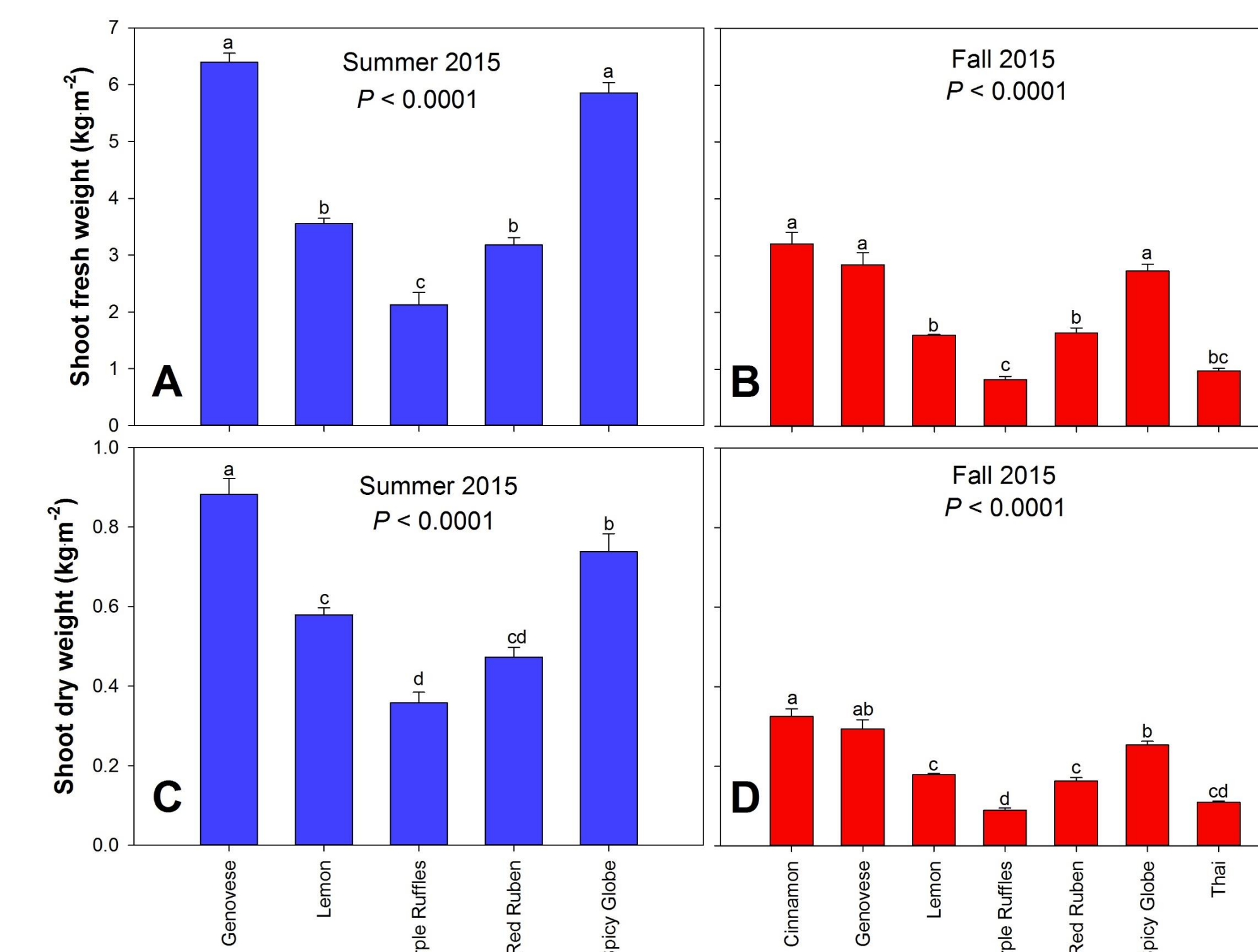

Fig. 3. Fresh weight on Summer 2015 (A) and Fall 2015 (B), and dry weight on Summer 2015 (C) and Fall 2015 (D) for different varieties of basil.

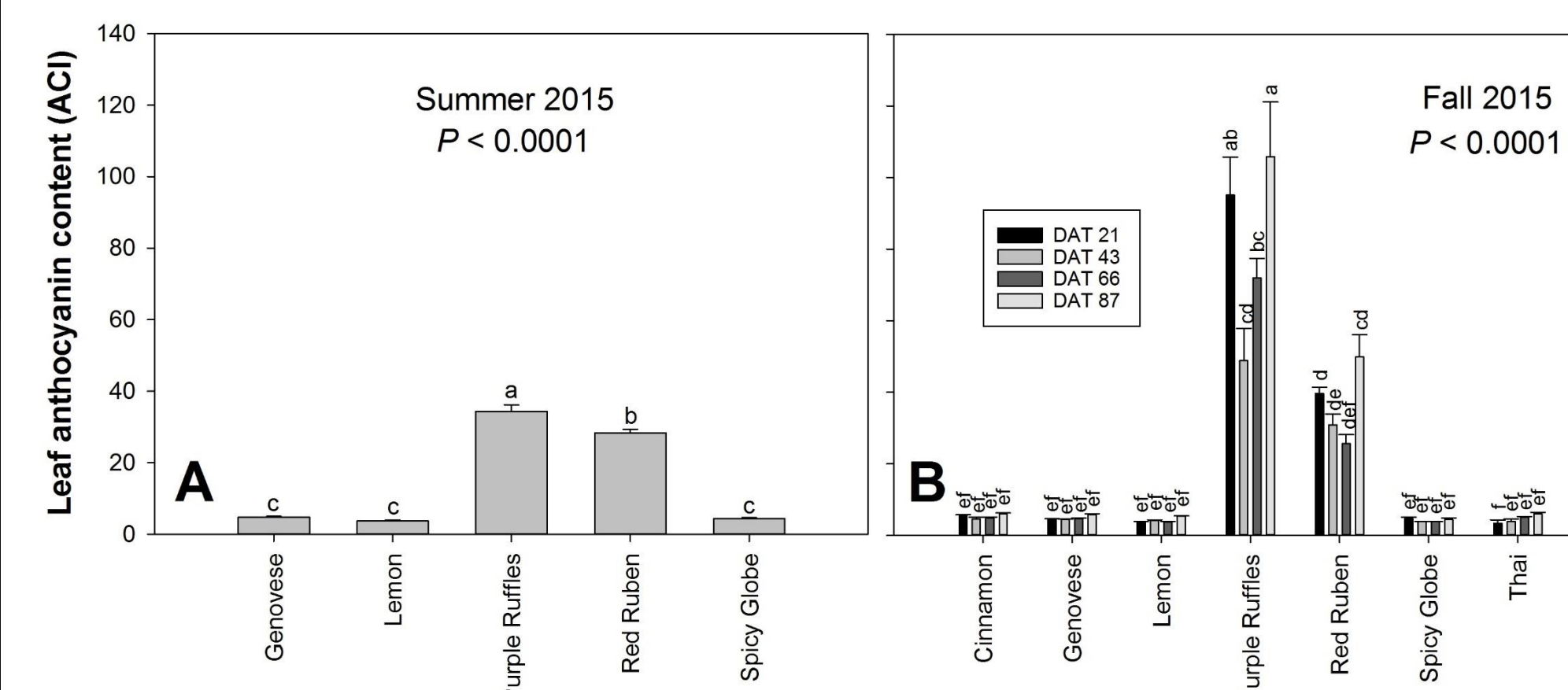

Fig. 4. Leaf anthocyanin content on Summer 2015 (A) and Fall 2015 (B) for different varieties of basil.

Plant growth index was higher on Genovese and Lemon (Summer 2015) on DAT 58 ($P < 0.0001$, Fig. 6A), and on Cinnamon (Fall 2015) on DAT 87 ($P = 0.0014$, Fig. 6B). Purple Ruffles was the smallest variety. Future trials could plant this variety at higher densities to increase production.

All varieties adapted well to the aquaponic culture conditions. Yield was greater during Trial 1 (Summer 2015), which was conducted May-August (Fig. 7A). Yield declined for the fourth harvest, indicating that a farmer may want to terminate production after the third harvest and replant the crop. Trial 2 (Fall 2015) was conducted September-November and shortening day length and less solar radiation could have impacted yield (Fig. 7B).

Conclusions

Based on our results, we recommend 'Spicy Globe' and 'Genovese' during Summer and Fall, were Cinnamon' is also an alternative. The total yield reflected the measured plant morphology. Varieties with smaller plant size can be spaced closely to increase total yields.

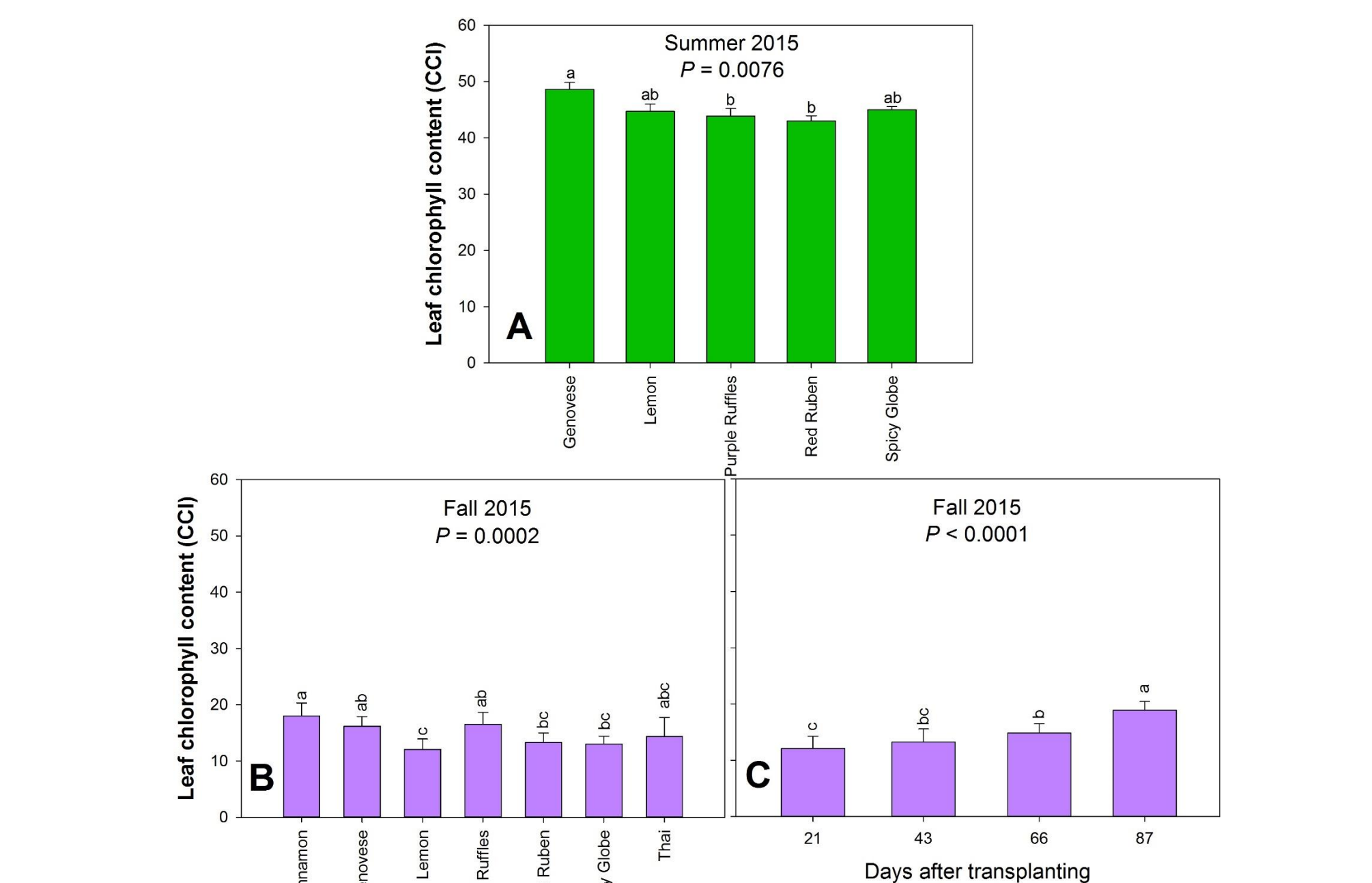

Fig. 5. Leaf chlorophyll content on Summer 2015 (A) and Fall 2015 (B and C) for different varieties of basil.

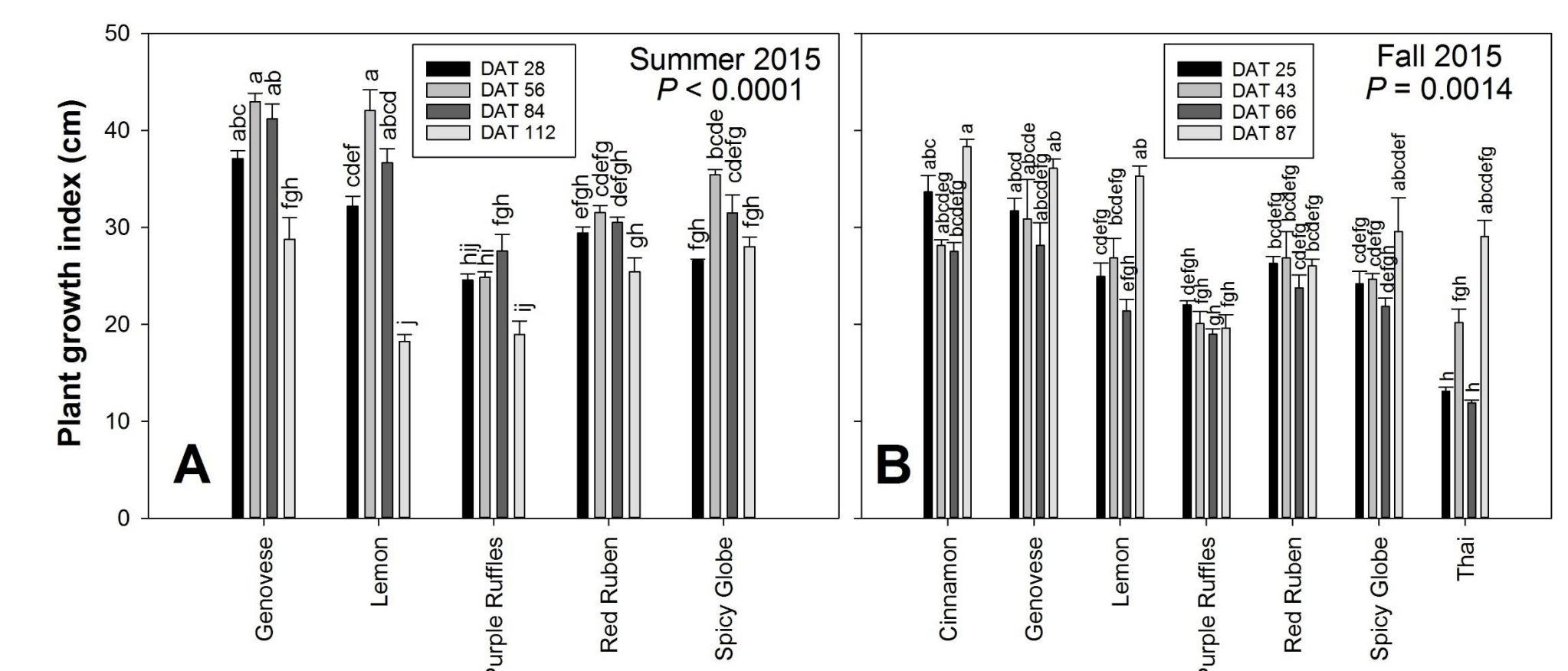

Fig. 6. Plant growth index on Summer 2015 (A) and Fall 2015 (B and C) for different varieties of basil.

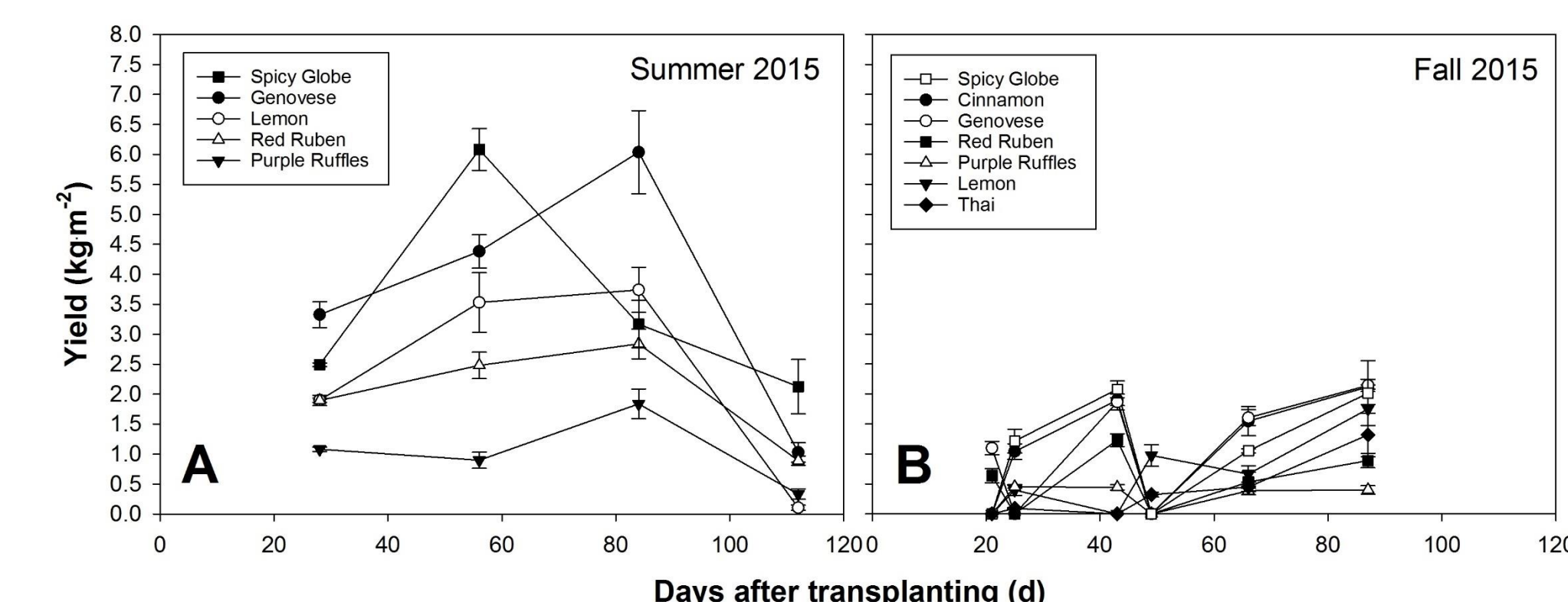

Fig. 7. Leaf chlorophyll content on Summer 2015 (A) and Fall 2015 (B and C) for different varieties of basil.

Acknowledgements

- Funding for this research was provided by USDA-NIFA-Hatch Funds.
- We thank Luis Carino Jr. and Donna Gonzales (Horticulture and Aquaculture program) for their technical assistance.